



PRODUCT LINE



Highest Quality, Best Service

Manufacturing chlorination equipment and related products since 1978



600 Emlen Way, Telford, PA 18969
www.hydroinstruments.com



Gas Feed Systems

Hydro Instruments has been manufacturing the highest quality gas chlorination and sulfonation equipment since 1978. A commitment to quality, safety, and convenience sets us apart from our competition.



(L-R) Series 500, Series 800, Series 900, Series 300

Design and Quality

All body parts are machined from solid PVC, designed with a heavy wall thickness to avoid cracks and breakage.

- Inlet capsules are made of solid Hastelloy-C276 or PVDF.
- Inlet valves are made of solid silver.
- All yoke assemblies are protected by the finest Epoxy Powder Coating.
- Vacuum regulator inlet and vent springs are all Tantalum.



Ease Of Operation

Included with every Vacuum Regulator is a Hydro Instruments twisted cylinder wrench. The wrench fits both cylinder valve and vacuum regulator yoke bolts.

Safety

Every component shipped by Hydro Instruments goes through a rigorous testing procedure.

Fast Service

Inventoried spare parts, components, and complete systems available to ship within 24 hours. Most orders will ship same day.



Floor Cabinets Available!

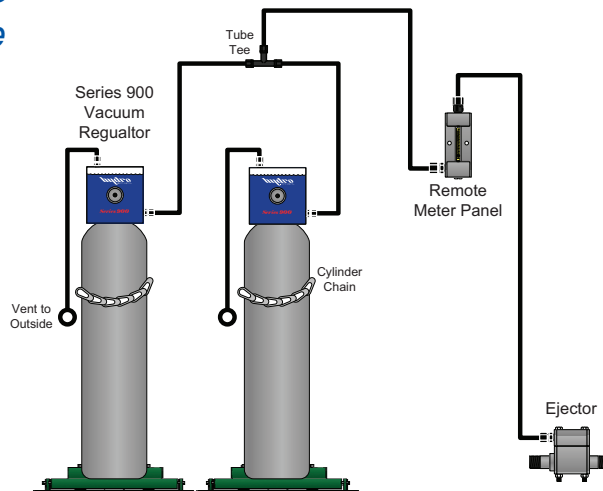

Hydro Instruments Series 900 Gas Chlorination System with Integral Switchover









Lifetime Warranty on inlet springs, diaphragm, inlet capsules and machined PVC bodies!

All vacuum regulators are backed by a 3 year warranty!

Complete line of Evaporators and Accessories up to 10,000 PPD (200 kg/hr)



Gas Feed Systems

	Series 500	Series 900	Series 300	Series 800	Series 3000	Series 700/750	Series 200
							
Capacity (PPD)	Up to 100	Up to 500	Up to 500	Up to 100	Up to 10,000	500	250
Ammonia Capacity (PPD)	Up To 50	Up To 250	Up To 100	N/A	5000	250	100
Gas	Cl ₂ SO ₂ NH ₃	Cl ₂ SO ₂ NH ₃	Cl ₂ SO ₂ NH ₃	Cl ₂ SO ₂	Cl ₂ SO ₂ NH ₃	Cl ₂ SO ₂ NH ₃	Cl ₂ SO ₂ NH ₃
Mounting	- Cylinder - Ton - Wall	- Cylinder - Ton - Wall	- Cylinder - Ton - Wall	- Cylinder - Wall	- Wall	- Cylinder - Ton - Wall	- Cylinder - Ton - Wall
Switchover	Module	Built-in	Module	Module	Module	Module	Module

This easy to read chart can help answer which Hydro Instruments chlorination system is right for you. Call the factory with any other questions. Hydro Instruments offers tubes graduated and marked specifically for Ammonia, Sulfur Dioxide, and Carbon Dioxide. Please consult the factory for details.

Gas Detectors

*Hydro Instruments manufactures two gas alarm systems the **GA-180** and the **GA-171**. Both systems provide reliable and simple solutions for gas detection applications. Both incorporate a basic modular design that can integrate a variety of gas sensor types and feature a user-friendly key pad interface for easy calibration and operation.*

GA-180



Available for
Cl₂, SO₂, H₂S, O₃,
ClO₂, H₂, O₂, NO,
NO₂, HCl, and NH₃

- Up to 16 individual gas sensors per monitor
- Available with 4-20 mA outputs for remote monitoring
- 10 alarm relays standard (available with up to 34 relays)
- Backlit liquid crystal display (LCD) for easy reading
- Built-in 90 dB audible horn
- Optional battery back-up
- Modbus RS-485 digital communication
- New optional high temperature alarm for heated rooms

GA-171



- One or two sensors per alarm module
- 1 Alarm contact relay
- Backlit liquid crystal display (LCD) for easy reading, 2 line / 20 spaces
- Built in normal / alarm LEDs
- Password Protection
- RS232 Output
- 4-20 mA Output

Automatic Valves

State-of-the-art microprocessor technology, highest quality materials, precision machining and a minimal number of moving parts all combine to make the **Hydro Instruments Automatic Valves** extremely reliable over long periods of continuous operation.



Hydro Instruments Gas Chlorination System with an OV-110 Omni Valve

We Build Custom Wall Panels!

CV-230 Control Valve

Compact Design!

Simple Proportional Program!

CV-230 Control Modes

Manual and Automatic (Proportional/Flow Pacing)



OV-110 and OV-1000 Omni Valve

The most versatile valve on the market!

Control Modes

Manual,
Proportional (Flow Pacing),
Set Point (Residual or ORP),
Compound Loop (PID),
Dual Input Feed Forward,
Dual Set Point, or Step Feed

Modbus RS-485
digital communication

Three analog inputs:
(Flow, Residual, and
Remote Dosage)



Both Models Provide:

- Automatic feed of Chlorine gas, Sulfur Dioxide gas, Ammonia gas, Carbon Dioxide gas, Sodium Hypochlorite and other liquid chemicals
- Linear drive design eliminates rotary motion, meaning minimal parts wear
- Contact alarm output and 4-20 mA (2) outputs standard
- Ten point linearization process for accurate feed control
- 2 line x 20 character display
- Capacities up to 10,000 PPD chlorine gas or 20 GPM Liquid Chemical Feed
- Excellent accuracy and repeatability

PID Controller

The **HC-220 PID Controller** offers the capability to control liquid chemical or gaseous chemical feed devices with a wide range of control options, adjustable features, and settings.

Each **HC-220 PID Controller** can perform proportional, set point, and compound loop control.



HC-220 PID Controller

- Liquid Crystal Display
- 4 Pushbutton User Interface
- RS-232 Output
- Alarm Relay Output
- 5 x Analog Inputs and 2x 4-20 mA Outputs for control
- Adjustable: Signal Filters, Lag Time, Display Ranges, and More
- Password Protected Control Settings

Residual Chlorine Analyzers

Does not rely on sample and hold methods!

Simple calibration and maintenance!

Allows for rapid process control!

Analyzers and parts are stocked for immediate shipment!



Series RAH-210:

- Amperometric residual analyzer
- Available range: 0 –.1 to 0 – 20 PPM
- Free Chlorine, Total Chlorine, Chlorine Dioxide, Bromine, and Iodine
- Continuous sensor cleaning mechanism
- Electrodes in direct contact with the sample water
- Available with a gravity driven reagent feeder, reagent metering pump, or with pH probe for automatic compensation



PRV and Pressure Gauge for a Hydro Instruments Residual Analyzer

Series RPH-250:

- Amperometric Probe-Style Analyzer for Free Chlorine, Total Chlorine, or Chlorine Dioxide
- Transparent bubble trap gravity style flow cell
- Available range: up to 200 ppm Free Chlorine
up to 20 ppm Total Chlorine
- Available up to 1,500 PPM range for free chlorine with sample water dilution system.
- pH probe can be included for independent monitoring or for automatic compensation when measuring free chlorine



Peristaltic Buffer Pump Model RAH-210-D



Standard Features On Both Models Include:

- Modbus Communication
- Automatic pH compensation software
- Continuous measurement and rapid response
- Continuous temperature monitoring and compensation
- 4 selectable isolated 4-20mA outputs (Residual, pH, Temperature or Control)
- 4 Alarm relays
- Complete PID control program
- Adjustable measurement range
- 2 line x 20 character LCD display

Liquid Feed Systems

Hydro Instruments' **Series LF Liquid Chemical Feeders** are a family of ALL-VACUUM chemical feed systems designed for the injection of a variety of chemical solutions.

Innovatively designed liquid feed systems allow for easy metering and adjustment of dosage. Unlike metering pumps, this system provides a visual indication of chemical feed rate.

- SAFETY: Chemical is fed under vacuum to avoid leaks common with metering pumps.
- Systems for feeding a variety of liquid chemical solutions (including Sodium Hypochlorite and others)
- Available feed rates up to 20 gallons/minute
- Precision made solid machined parts of only the highest quality and most chemically resistant materials
- Automatic control and automatic compensation of feed rate

Hydro Instruments' Series LF systems are in use around the world metering the following chemicals:

- Sodium Hypochlorite
- Sodium Chlorite
- Hydrochloric Acid
- Sulfuric Acid
- Sodium Bisulfite
- Sodium Bisulfate
- Sodium Thiosulfate
- Fluoride
- Liquid Ammonium Sulfate

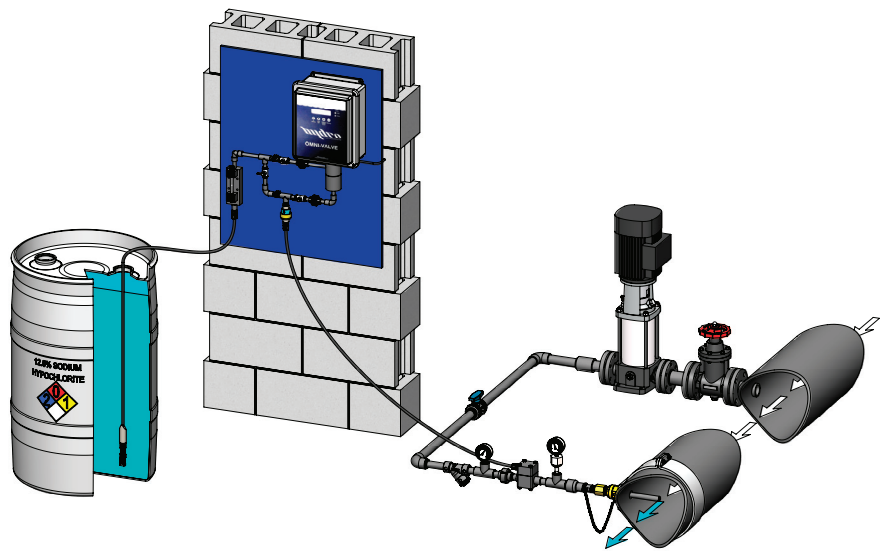

Safety of an All Vacuum System

No Vapor Locking

V-RAD

Vacuum-Revolving Automatic Doser

A new reliable alternative to metering pumps!

- **Metering orifice is self-flushing and will not clog!**
- Accurate and repeatable feed control of liquid chemicals **under vacuum** (such as Sodium Hypochlorite)
- Designed for feed rates of 0.1 through 4 GPH, **Higher Capacities Are Available**
- Provides manual or automatic feed rate adjustment
- Allows for controlled timed pulses of liquid chemical
- Accepts 4-20 mA input signal for proportional control
- 4-20 mA output



No Vapor Locking!

No Clogging!

Absolute Control and Reliability!

Guaranteed!

Accessories

Corporation Stops



- Standard solution-wetted materials include PVC, CPVC and 316 SS
- Hydro Instruments offers customized solution tube lengths and inlet connections for no additional charge (upon request)
- Available with threaded socket or hose barb inlet connections

Size and Material Options

Sizes	Ball Valve	Solution Tube Assembly
1/2"	PVC, CPVC	PVC, CPVC
3/4"	Brass, PVC, CPVC	PVC, CPVC
1"	Brass, PVC, CPVC	PVC, CPVC, PVDF, PTFE, Stainless Steel
1 1/2"	Brass, PVC, CPVC	PVC, CPVC, Stainless Steel
2"	Brass	PVC, CPVC

Check Valves



Ejectors



PGS-14-EW Pressure Gauge with adjustable switches



Hydro Instruments offers a complete line of chemical feed accessories to complement any installation.

Vacuum Tubing and Tube Fittings



UV Resistant PVDF

VSH-683 Vacuum Solenoid Valves



Vent Arrestor



Isolation Valves

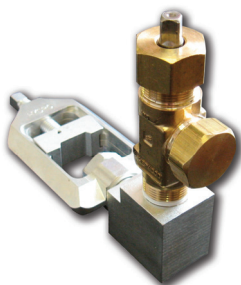

Flexible Connectors



Pressure Reducing Valves

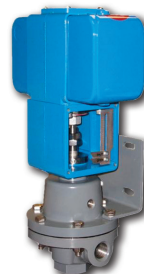

- Calibration Columns
- Modular Vent Valves
- Gauges, Switches, and Solenoids
- Water Inlet Assemblies
- Drain Valves
- Open Channel Diffusers
- Differential Pressure Regulators
- Pressure Changeover Systems